

Exhibitions for All

A practical guide to designing inclusive exhibitions



- **General and Physical Access**

entrances, doors, ramps, stairs, signs, orientation, exhibition planning, seating, exits and escape provision

- **Communication and Display**

showcase displays, interactive exhibits, writing text for exhibition graphics and labels, word counts, positioning labels, layout, pictures, typography, publicity materials, using plain english, type sizes, symbols, paper and printing, alternative formats

- **Audio Visual Presentations**

audio visuals, subtitle production

- **Lighting**

entrances, main routes, display lighting, light levels

- **Further Information**

the law, voluntary guidelines, useful reading

This guide will help exhibition planners, particularly designers, provide physical, sensory and intellectual access to exhibitions in museums and galleries. It is written mainly with disabled people in mind and so takes into account the legal requirements of the Building Regulations and the Disability Discrimination Act. However it also embraces the concept of Inclusive or Universal Design: design that attempts to meet the variety of needs of all its users.

NMS Publishing Ltd, Edinburgh 2002

Published by NMS Publishing Ltd

© Trustees of the National Museums of Scotland 2002

No part of this publication may be reproduced, stored in a retrieval system or transmitted, in any form or by any means, electronic, mechanical, photocopying, recording or otherwise, without the prior permission of the publisher.

British Library Cataloguing in Publication Data

A catalogue record of this book is available from the British Library

ISBN 1 901663 00 0

Designed and printed in Scotland by NMS Design Office

Copies of this publication are also available in large print, on request, from:

NMS Publishing Ltd

Chambers Street

Edinburgh

EH1 1JF

Telephone (+44) (0)131 247 4026

Fax (+44) (0)131 247 4012

e-mail publishing@nms.ac.uk

web site www.nms.ac.uk

Exhibitions for All

A practical guide to designing inclusive exhibitions

This guide will help exhibition planners, particularly designers, provide physical, sensory and intellectual access to exhibitions in museums and galleries. It is written mainly with disabled people in mind and so takes into account the legal requirements of the Building Regulations and the Disability Discrimination Act. However it also embraces the concept of Inclusive or Universal Design: design that attempts to meet the variety of needs of all its users.

Designed and printed in Scotland by:

NMS Design Office

Department of Technical Services
Chambers Street
Edinburgh EH1 1JF

Telephone (+44) (0)131 247 4026
Fax (+44) (0)131 247 4012
web site: www.nms.ac.uk

© Trustees of the National Museums of Scotland 2002

Acknowledgments

The first edition of this guide was compiled and illustrated by Gail Nolan, in 1997, at the the National Museums of Scotland.

This edition has been revised by James Mackay, NMS Technical Services Department, Design Section and Christine Thompson, NMS Education Section.

The NMS is grateful for the encouragement and advice received from the following organisations during the compilation of this guide:

Centre for Accessible Environments

Resource: The Council for Museums, Archives and Libraries

The Scottish Arts Council

The Arts Council of England

The Royal National Institute for the Blind

The Royal National Institute for Deaf People

The RNIB/GDBA Joint Mobility Unit, Scotland

Acknowledgments page 2

Introduction page 4

Section 1 General and Physical Access page 5

- 1.1 entrances and doors
- 1.2 ramps, stairs and lifts
- 1.3 signage and orientation
- 1.4 exhibition planning
- 1.5 exits and escape provision
- 1.6 seating and rest areas

Section 2 Display and Communication page 12

- 2.1 showcase and object displays
- 2.2 interactive displays
- 2.3 exhibition graphics and labels : writing text
- 2.4 exhibition graphics and labels ; word counts
- 2.5 exhibition graphics and labels : positioning
- 2.6 exhibition graphics and labels: layout
- 2.7 exhibition graphics and labels: pictorial information
- 2.8 alternative formats of labels
- 2.9 typography and layout: general principles
- 2.10 printed / publicity material
- 2.11 language
- 2.12 using plain English
- 2.13 print sizes for publicity material
- 2.14 images
- 2.15 use of symbols
- 2.16 paper and printing
- 2.17 alternative formats

Section 3 Audio Visuals and Subtitles page 26

- 3.1 audio visual elements and subtitles
- 3.2 production and appearance of subtitles
- 3.3 presentations without subtitles
- 3.4 silent presentations / presentations with music
- 3.5 other AV considerations

Section 4 Lighting page 28

- 4.1 lighting entrances and main routes
- 4.2 display lighting
- 4.3 lighting maintenance
- 4.4 light levels
- 4.5 light colour / quality

Section 5 Further information page 30

- 5.1 statutory obligations
- 5.2 voluntary guidelines
- 5.3 useful addresses
- 5.4 useful reading

Appendix : Disability facts and figures page 32

Exhibition design and access

When planning and designing an exhibition, the exhibition team must address the statutory access requirements for people with disabilities. These are detailed in the respective Building Regulations for Scotland, England and Wales, and Northern Ireland, and in other relevant standards (see page 29). However these requirements provide a minimum standard for physical access only.

The passing of the Disability Discrimination Act in 1995 gave disabled people more rights in several areas, including access to services. As a result, museums and galleries, as service-providers, now have to take reasonable steps to make their exhibitions reasonably easy for disabled people to use.

Making exhibitions accessible need not be difficult or expensive as long as exhibition planners and designers bear the requirements of disabled people in mind from the start of the project. Their guiding principle should be that of Inclusive or Universal Design. This is an approach to design that sets out to include as many people as possible throughout their life.

There are many sources of advice on inclusive design. This publication draws them together and applies them to the specific problems of exhibition access and interpretation.

The Disability Discrimination Act (DDA) and disability

The DDA is being implemented in several stages. Since 1999 service providers (such as museums) have had to amend policies, practices and procedures that make it impossible or unreasonably difficult for disabled people to use their services. They should also provide auxiliary aids and services to allow disabled people access to their services.

The legal definition of disability is “a physical or mental impairment which has a substantial and long-term adverse effect on a person’s ability to carry out normal day-to-day activities”. However most disabled people prefer the “social model” of disability that holds that disability results from barriers created by society. It is supported by the Government, and by Resource, and should be adopted by museums.

Access for all: the concept of Inclusive or Universal Design

Providing access for disabled people should be seen as an opportunity to provide better access for all. An exhibition that displays objects too high for wheelchair users to see disables them - and children.

Information in small print disables visually impaired people - and most senior citizens. Information only in print disables people who prefer to learn through listening or touching. By considering the variety of needs that their visitors have, and designing exhibitions to suit, museums will provide a better experience not only for disabled people, but for all. This is the basis of the concept of Universal Design.

A sympathetic approach

It will not be possible to design an exhibition that is completely accessible to all people in every way. However an understanding of the needs of disabled people will help designers to avoid creating unnecessary barriers to access and communication in their exhibitions.

The practical measures in this guide should not be treated as obstacles, or additions to be 'stuck on' at the end of the creative process. Instead, designers are encouraged to embrace the spirit of access and incorporate the necessary design solutions into the overall design from the outset.

1.1 Entrances and doors

Level access should be maintained at all entrances and exits, with a clear approach and good circulation space either side of the doors (minimum of 1500mm² at each door). Keep gallery doors open on magnetic closers, or provide a call button where environmental controls prevent this.

The entrance should be welcoming, clearly visible and well signed. The entrance should also be easily identifiable by contrasting it with the surrounding structure - use colour, tone and a change of material.

A bright 'visibility band' or logo should be provided on all glazed doors, between 900 - 1500mm from finished floor level (FFL). Alternatively, use a combination of a 150mm wide band between 850 - 1000mm and a logo at eye level (1400 - 1600mm). The band/logo should be visible from both sides.

Provide a glazed vision panel in solid doors 900 - 1500mm from FFL.

Clear operating instructions (push/pull etc) should be incorporated into the door design, with either push plates or lever handles for ease of use. Incorporate a kick plate at ground level which is 400mm high. Ensure all ironmongery is positioned consistently and contrasts with the door finish.

1.1 Entrances and doors

Single doors should be a minimum of 800mm wide, but preferably 1200mm, and double doors should be a minimum of 1600mm wide.

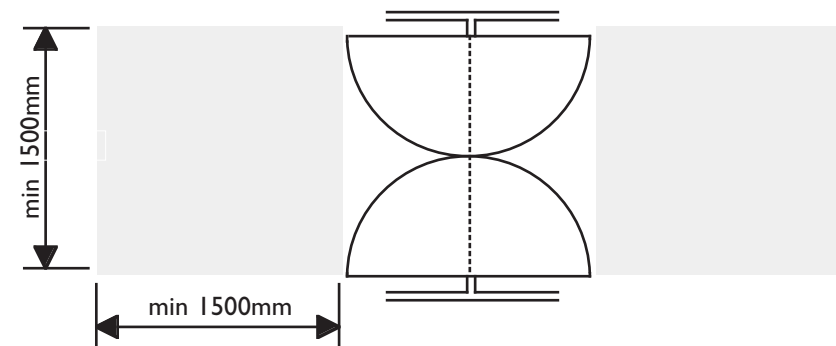
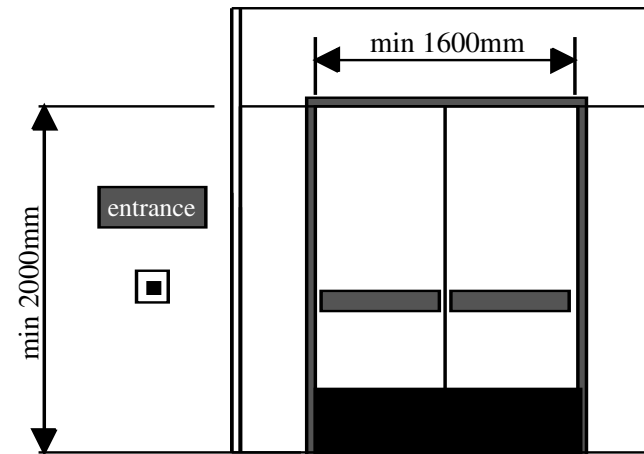

1.2 Ramps, stairs and lifts

Level wheelchair access is essential throughout an exhibition; therefore changes of level are generally discouraged.

If necessary, the level-change should be minimal, and via a ramp, or steps accompanied by a ramp. Note that if a ramp gradient exceeds 1 in 15, some people may find steps easier to negotiate; so always provide a choice.

Ensure that stairs and ramps are always adjacent. People who cannot manage the stairs should not be sent on a longer route, or one that interrupts the exhibition sequence.

Where there is a raised floor area higher than 600mm, a protective barrier 1100mm high should be provided. Incorporate transparent sections so children and wheelchair users can view the lower levels.

Leave clear circulation spaces of 1500mm² at the top and bottom of raised areas, and at the entrances to lifts.

Stairs and ramps can be hazards for people with visual impairments or mobility problems, unless they are highly visible, secure and easy to negotiate. The following illustrations show the main features of accessible stairs and ramps, but it is advisable to have the plans checked by a local disability organisation or access consultant.

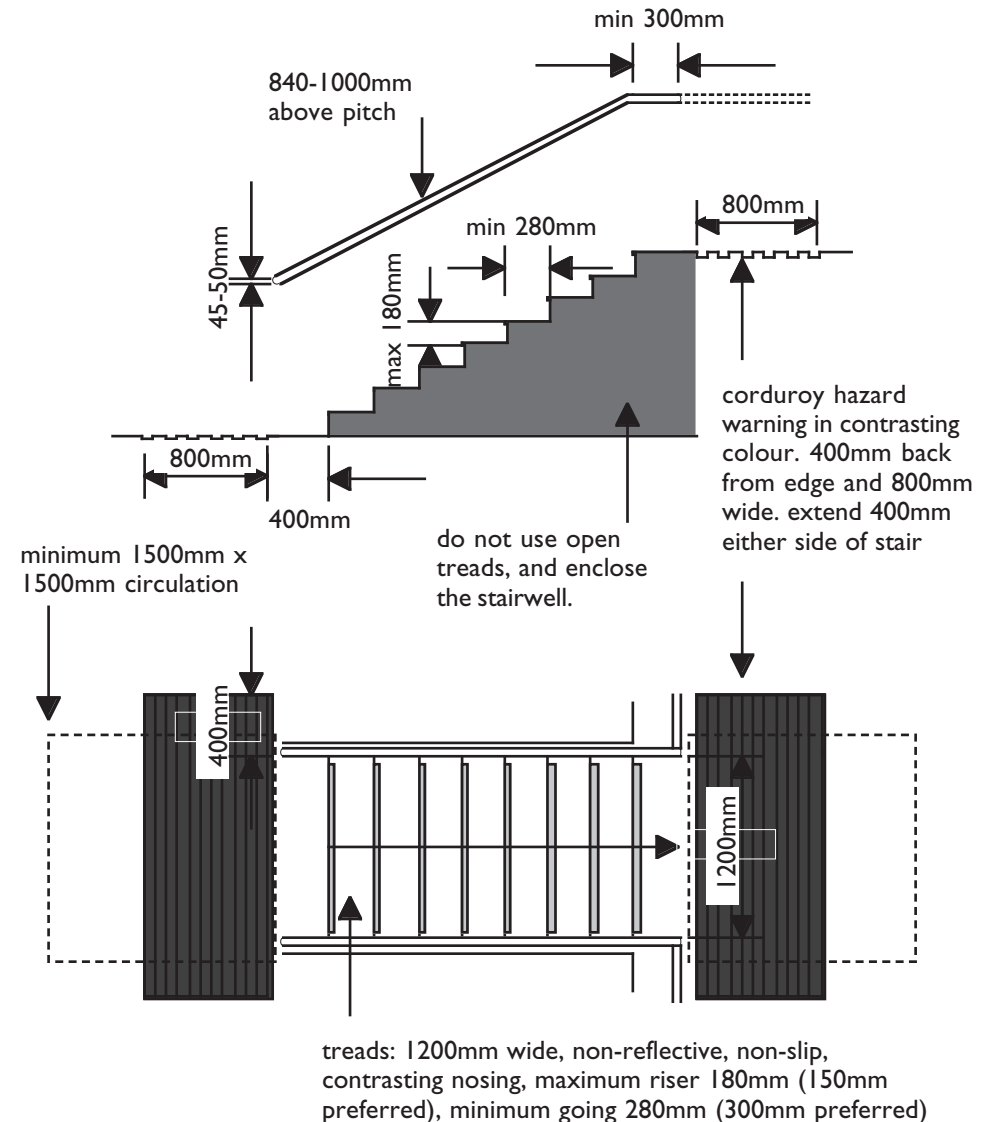

1.2 Ramps, stairs and lifts

Regardless of gradient or length of the ramp, handrails should be provided on both sides of a ramp, and a stair or ramp more than 1800mm wide must be divided by a centre handrail, ensuring at least 1200mm is retained between the rails.

Handrails should be continuous, preferably circular in cross-section. The preferred diameter is 45-50mm and the rail should contrast with surrounding surfaces.

Handrails are also very useful as guide rails around an exhibition, and can provide psychological support for people with mobility problems or visual impairments.

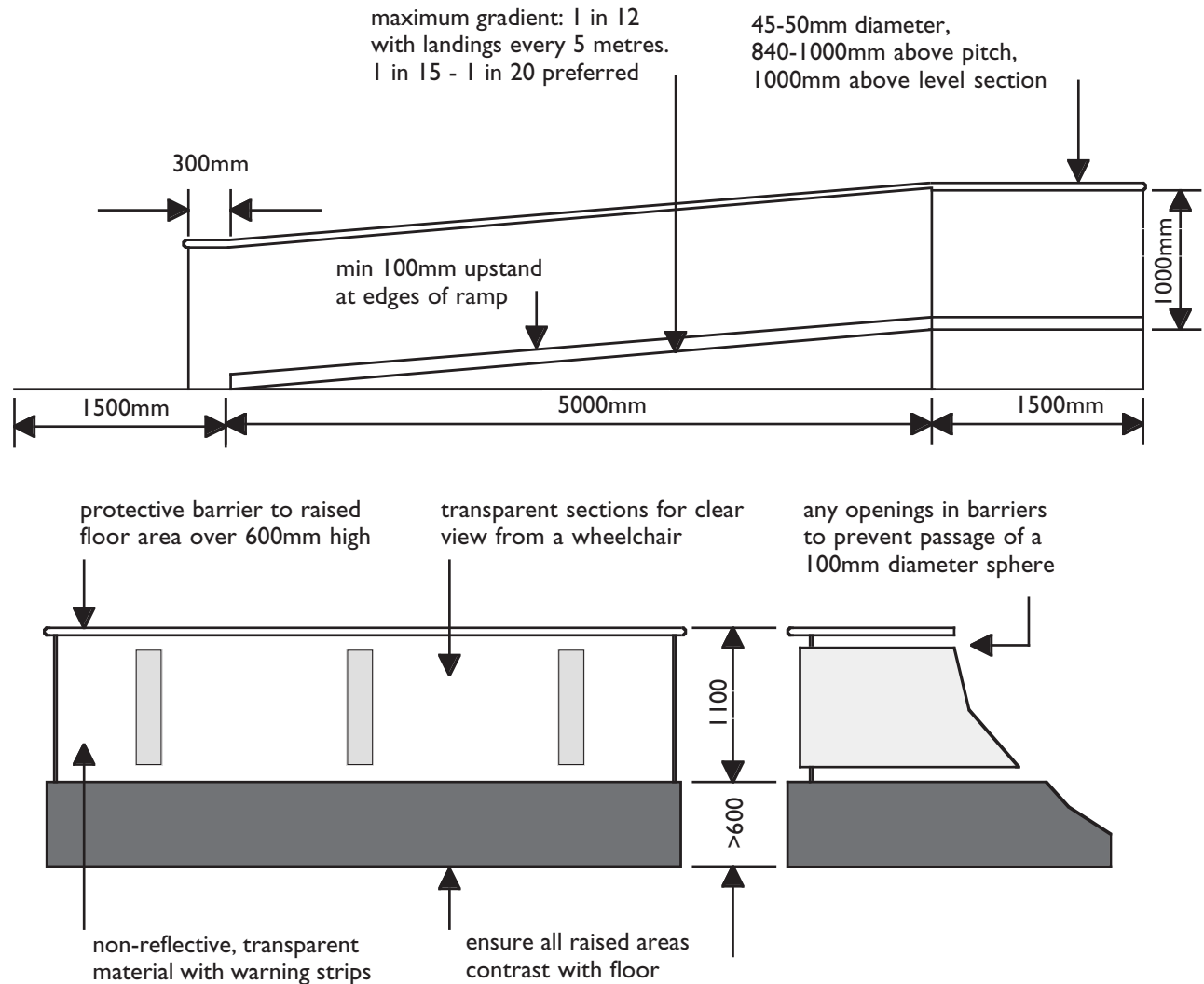

1.3 Signage and orientation

Signage should be simple, short and consistent in design and layout. Signs should contrast well with the surface they are mounted on, be well lit and be fixed at a consistent location (eg always to the left) and consistent height, between 1400 - 1700mm above FFL .

Signs should employ good contrast (equal to 70% or more); use a matt surface with clear, legible typography (see section 2); and make use of recognised symbols where appropriate.

Orientation aids should be provided, eg a map (preferably tactile) of circulation and sections of the exhibition. Supply printed exhibition guides with floor plans (available in large print) and a portable audio guide (with inductive coupler) with clear descriptive language and directional instructions in the commentary.

Tactile signage which incorporates Braille (raised, dome-shaped dots that can be read by touch) or raised letters and pictograms is essential for people with no sight at all and deafblind people. If you use tactile signage ensure it is positioned where it can be touched.



Use simple, consistent symbols where appropriate.

From left:

wheelchair-accessible symbol,
induction loop or other equipment for enhanced sound,
audio facilities eg audio tour or radio aid
special facilities for visually impaired people.

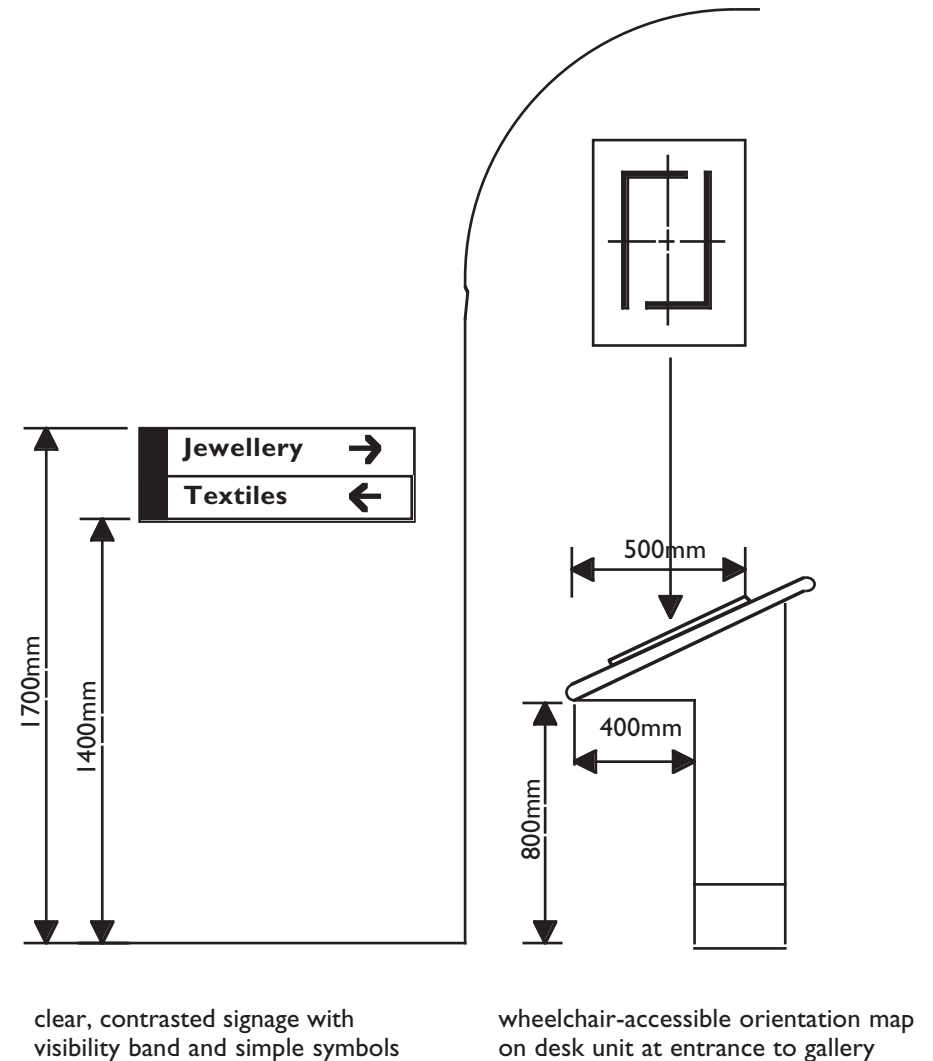

1.4 Exhibition planning

Avoid complex or tortuous circulation routes and long 'cul-de-sacs' where visitors would have to double back, increasing muscular fatigue and visual disorientation. Provide a clear numbering system with signage to make a logical, easy-to-follow route.

Primary circulation and escape routes should be 1500mm wide minimum (but may be reduced to 1200mm where unavoidable, eg for internal doorways). Allow 1500mm x 1800mm minimum at about-turning points. The circulation around individual displays (not on the primary route) can be as little as 900mm if necessary. Aim for generous passing spaces, avoiding bottlenecks around displays.

On circulation routes, avoid finishes difficult to negotiate by wheelchair users or people with mobility problems, such as loose gravel, cobbles or deep-pile carpets. Keep floor finishes matt to avoid the visual confusion of reflections and glare.

Use colour, tone and decoration to contrast wall, floor and ceiling planes, door surrounds, free-standing objects, overhangs or other potential hazards. Avoid strong, vibrant patterns as these are disorienting.

Avoid projections if possible, or provide visual and tactile warnings, plus a guard rail when the overhang exceeds 305mm below a height of 685mm, or 100mm above this height (unless incompatible with use, eg desk/computer).

1.4 Exhibition planning

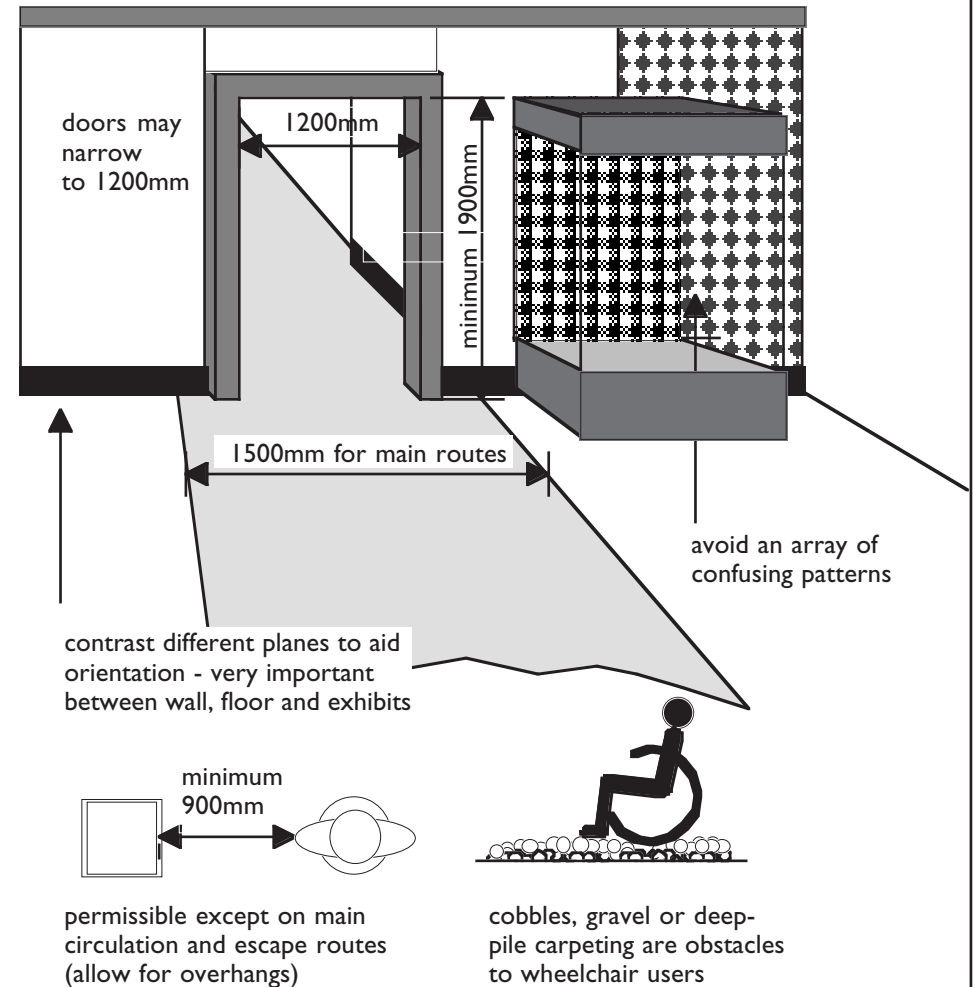

1.4 Exhibition Planning

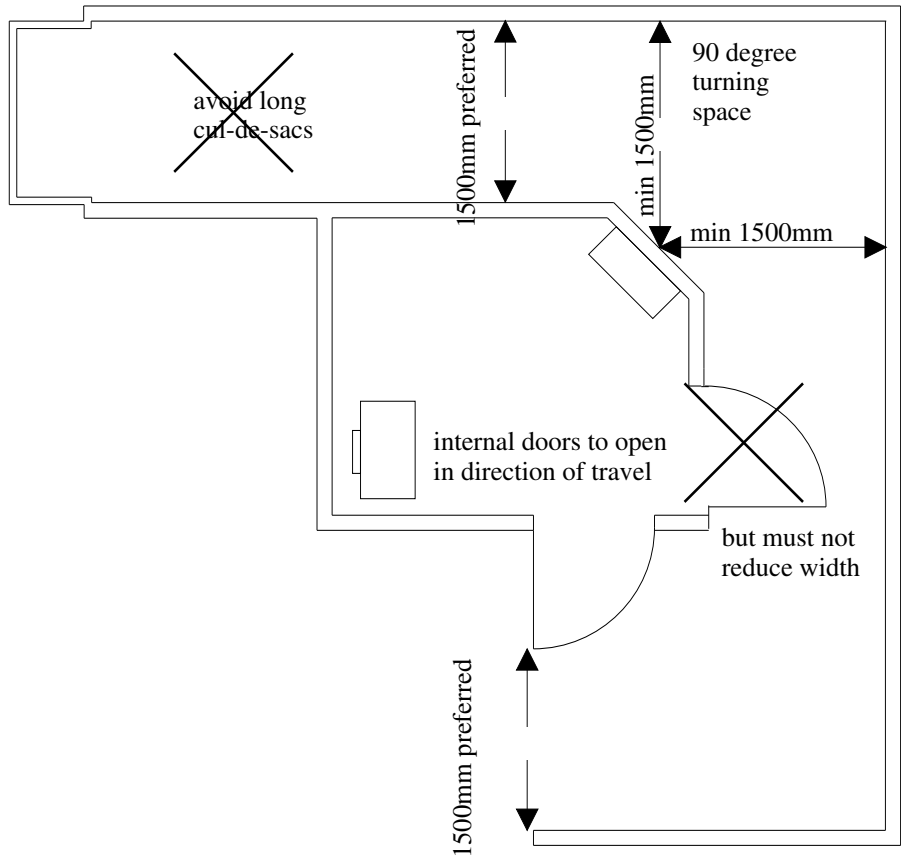

1200mm is the minimum width for escape routes but 1500mm is preferable

1.5 Exits and escape provision

If the direction of escape cannot be clearly seen from any point, tactile arrows should be provided on cases, partitions and hand rails, indicating the direction of escape. They should be 5mm thick and at least 25mm high, set on top of hand rails and at the same height throughout.

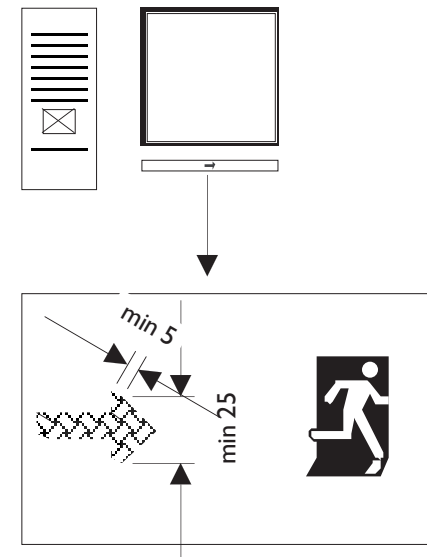

tactile arrows along escape routes, indicating direction of escape

1.6 Seating and rest areas

In larger temporary exhibitions or new, permanent galleries, seating and wheelchair rest spaces should be provided just off the main circulation routes and evenly spaced throughout the exhibition. These are ideally situated at natural breaks or rest points in the exhibition story or facing large or key objects which visitors may wish to sit and spend some time viewing, sketching or taking notes.

A variety of seating should be provided to accommodate visitors' differing requirements. Exhibitions aimed at children, for example, would require seating suitable for both children and adults accompanying them, who may wish to sit while the children enjoy the activities.

Chairs or bench seating should consist of a firm seat 280 - 420mm deep, located at 400 - 500mm above FFL. Some seating should have arm rests at 650 - 750mm above FFL and also with a back support. These aid people with mobility problems when lowering and raising themselves to and from the seat. Sufficient room should be allowed next to public seating for a wheelchair user to sit alongside or to allow them to transfer themselves onto the seating.

Perch seating 650-800mm high is appreciated by visitors with chronic back problems who will also welcome a bench seat in or near the exhibition where they could lie down for short periods if required.

Ensure that the seats contrast with the flooring, and are not positioned under wall-mounted exhibits or text or in front of control buttons for a lift or door.

Some visitors will appreciate the ability to move a lightweight chair or stool within a gallery to sit near an exhibit of interest or to carry with them during a guided tour, as they may find standing uncomfortable even for short periods. This will not always be a feasible solution in

every gallery or exhibition due to circulation routes and fire and safety regulations. However a system of providing a seat on request will add to the accessibility of the displays. If you do offer this facility make sure you let visitors know in advance in your publicity materials or access guide.

Avoid using low furniture, such as coffee tables, which can be a particular hazard for visually impaired visitors, and could also prevent access to seating areas for people with mobility problems.



Seating with backs, small tables and a choice of arm-rests, situated just off the main circulation route is an ideal combination.

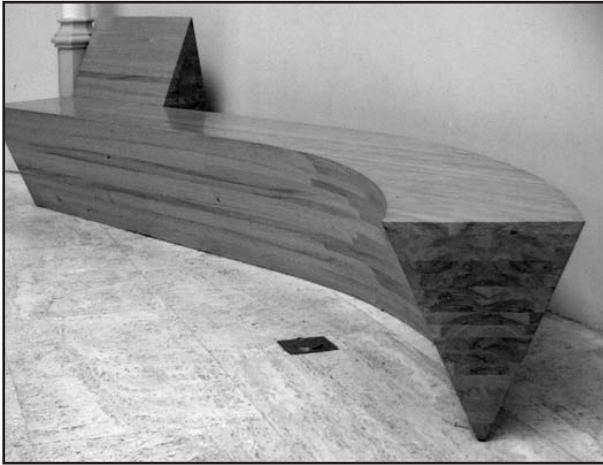

A variety of seating solutions will accommodate visitors with different requirements and can target different age groups as well as fit into very different displays and design schemes. Tables alongside seating are appreciated as places to lay down bags or spread out gallery plans and printed information. Some can be a design feature on a gallery or even add an element of fun.

2.1 Showcase and object displays

All displays, cased or otherwise, should fall within the general optimum viewing band of 750-2000mm from FFL, with smaller or detailed objects and main text falling within the narrower band of 1200-1600mm above FFL. Ensure everything is visible from a wheelchair.

Desk cases should be no higher than 800mm from FFL, with a 400mm minimum overhang and 800mm wide clear space underneath for wheelchair parking. Add a further 800mm to the width of the adjacent passageway to prevent obstructions.

Visitors should be clearly invited to touch open displays wherever possible, and the object(s) should be placed at wheelchair-accessible height. Consider providing braille labels, placed flat, or at a low angle not exceeding 45°. You should also provide opportunities to use the sense of smell, eg spice jars, herb sachets, floral perfumes, etc as appropriate.

Provide a toe space of 224mm high x 180mm deep around constructed walls, cases and large plinths to allow wheelchair access, or space for a wheelchair to draw alongside the case.

Ensure there is sufficient viewing space for large objects, photographs, paintings etc, by avoiding displaying them in a constrained viewing environment where bottlenecks may occur. Provide a three dimensional or tactile scale model of very large objects, eg elephant, steam train.

2.1 Showcase and object displays

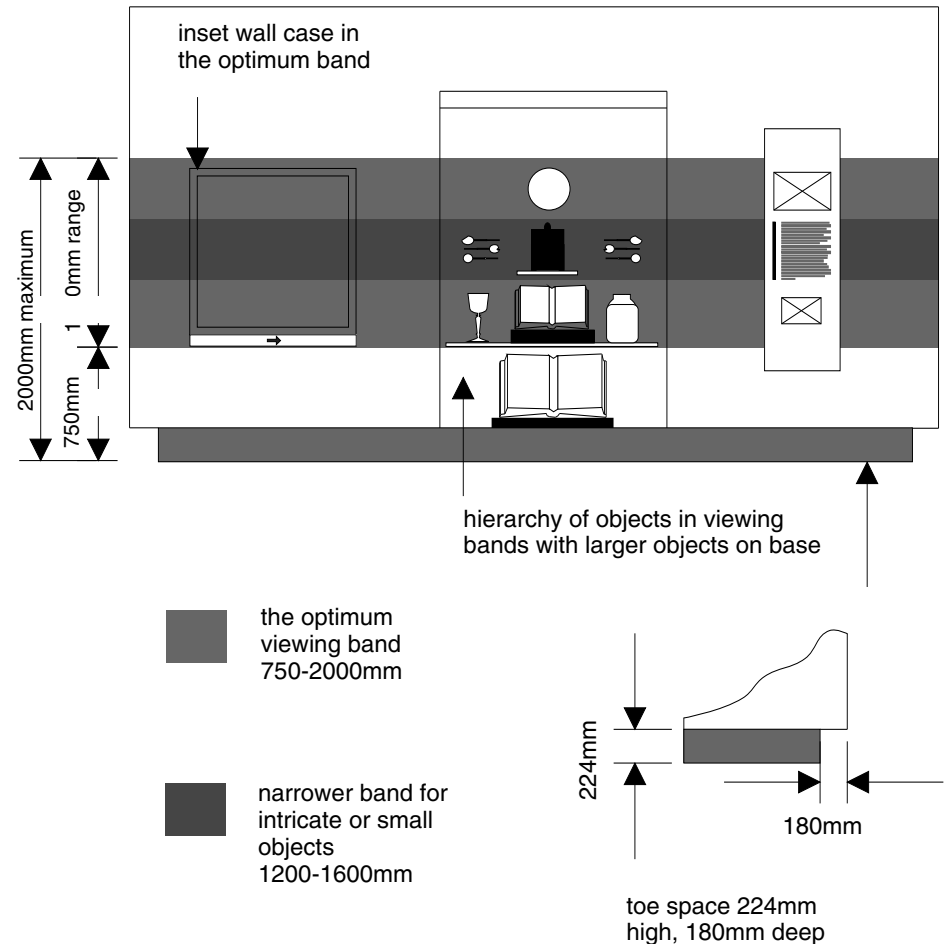

2.1 Showcase and object displays

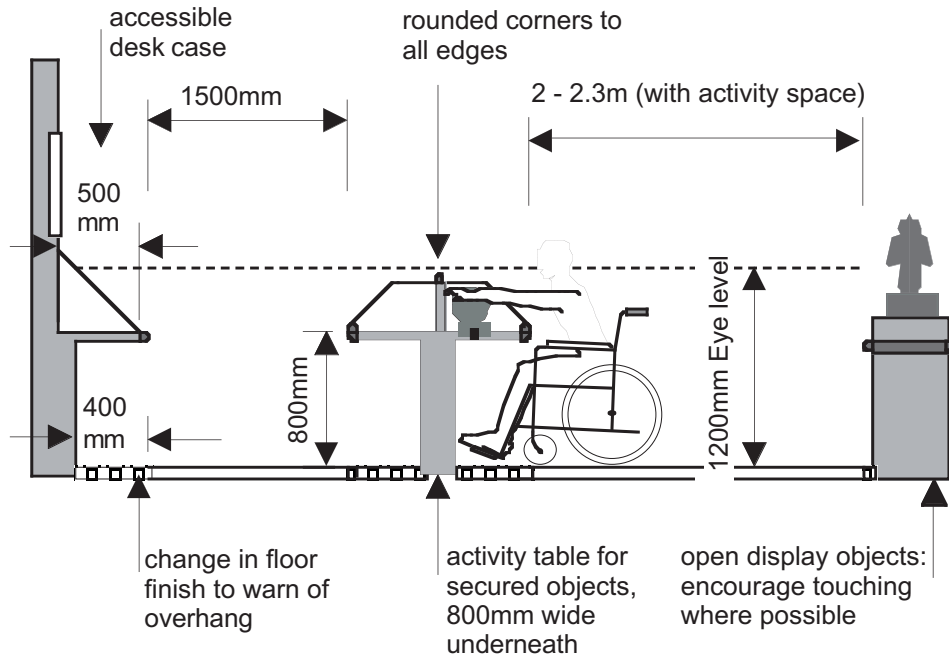

2.2 Interactive displays

Activity surfaces or computer stations should be no higher than 800mm from FFL, fully accessible for a parked wheelchair (no solid fronts or obstructions, as for desk cases).

Work surfaces should be lit to a level of at least 200 lux. Interactive screens should be shielded from direct sunlight and bright light sources. The display should allow people with low vision to get their faces close to the screen. If there is an inductive loop facility, remember to sign this clearly.

Push-buttons or operational features should be easy to operate (by arthritic hands, in reach of wheelchair users etc), and easy to comprehend. They should contrast with the background. There is an increasing number of types of controls available and considering a variety of needs will help inform your choice. Some points to consider are:

- colour: do not use colour alone as a means of differentiation.
- size: a larger size can significantly help some users
- buttons should be able to be pressed by visitors with various levels of dexterity
- touch: all keys or buttons should preferably be raised by a minimum of 2mm.

Buttons and other interactive features should be located 1050mm above FFL, if wall-mounted.

Operating instructions should be clear, concise and featured prominently on the desktop or wall-mounted within the narrow viewing band of 1200-1600mm above FFL.

2.3 Exhibition graphics and labels : writing text

Know your audiences. Are they family groups, schoolchildren, academics, people who don't normally go to museums, special-interest groups...? Consult them over what they want to see, hear, touch, smell and perhaps taste. Agree with them what they will learn, how they will feel and what they will do in, and out, of the exhibition. How do they like to learn: by doing things or quietly reflecting? Do they like to feel safe with the familiar or are they excited by the new?

Bear in mind that visitors will have a wide range of literacy levels. One in five adults in Scotland is "functionally illiterate", meaning he or she finds it difficult to read and write at the level required to cope best with all aspects of daily life.

To cater for a wide range of literacy, use Plain English and aim at a reading age of about 12 or 13 for main messages and up to 15 for additional information. (There are tests for reading age and ease of comprehension of text in museum studies publications.) Such language need not be over-simple and patronising. It enables fast comprehension while standing and is accessible to Deaf people, whose first language is Sign language, people with learning difficulties and overseas visitors.

For more information on giving information in print, see sections 2.10 - 2.17 and the Plain English Campaign website <http://www.plainenglish.co.uk>

2.4 Exhibition graphics and labels : word counts

When writing text for an exhibition it should always be remembered that it is not a book or an article for publication but a storyline that supports objects in a physical space and environment. The readers will mostly be standing and have the distractions of objects, exhibits and other visitors around them. The visitor will normally have a maximum visiting time of an hour to read, consider and understand your story as well as interpret and enjoy the objects shown. With this in mind having suitable text lengths for exhibitions is paramount.

word counts guide

Introductory or theme panels	100 words max
Topic or section panel	150 words max
Sub section or case panel	200 words max
Object label	25-50 ideal, 75 words max

More detailed information can be provided on hand-outs, exhibition publications or by audio or computer interactive for visitors who wish to read more about a topic or particular object.

2.5 Exhibition graphics and labels : positioning

Labels should be placed at an appropriate angle for viewing (ideally at 90° to the line of vision) and as close to the viewer as possible. They should also be easy to read by wheelchair users who will have a lower optimum viewing height and bifocal wearers who may have difficulty focusing on labels positioned at the back of cases.

Ensure labels can be read, and objects seen, from the same vantage point. Provide a clear numbering system (large point size) and an additional graphic link, eg the shape of the object on a simple plan of the case or a simple object description, repeated on the main label and next to the object number.

2.5 Exhibition graphics and labels : positioning

Graphics and labels must be positioned at the optimum viewing height (750 -2000mm above FFL or 1200 - 1600mm for detailed text).

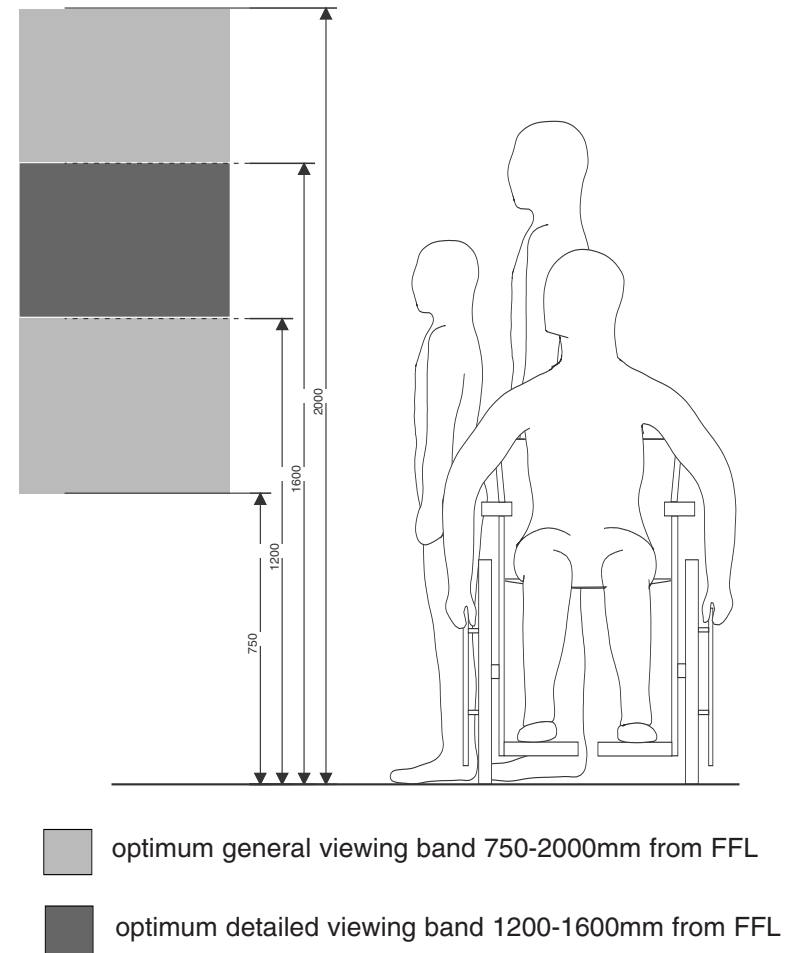

2.6 Exhibition graphics and labels: layout

Use simple, well-spaced paragraphs and layout, with a clear hierarchy of title, main message, further detail, captions and credits.

The addition of a contrasting band on the left of paragraphs can aid readers to find their place in the text. Bullet points and rules between columns or unrelated sections also help navigation.

Body text on introductory graphic panels and main exhibition storyline panels should be 36pt upwards. A full-size mock-up in situ will confirm if your text is legible or whether you need to increase size or contrast.

A minimum type size of 18 - 36pt is suitable for the body text of most exhibition object labels. It may be acceptable to use text as small as 14pt with a clear font printed in high contrast and if the viewing distance to the label is less than 500mm (when it is positioned within the optimum detailed viewing band 1200 - 1600mm above FFL). Text at this size can be made more accessible by presenting it as a hand-held label or booklet easily referenced to the objects.

If text is intended to be read from a distance or falls outwith the optimum viewing bands (eg large titles or banners), or if the lighting conditions are less than ideal, then the size and spacing of text must increase considerably in compensation.

Because there are so many factors affecting legibility of type, mock-ups are an essential part of exhibition print design, preferably viewed in the actual gallery conditions by a group of readers, representative of your intended audience.

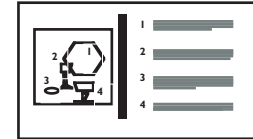

labels with graphic links to the objects, placed as close as possible to the displays

when using reverse text, contrast should be very high and type not too small, lightweight or bold



small/fine object on enlarged photo

embossed/raised text aids people with visual impairments

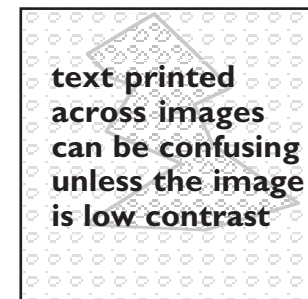

good contrast, limited fonts, legible text case, even word spacing, left justification, well spaced columns, visibility bands, hierarchy of text, no jargon

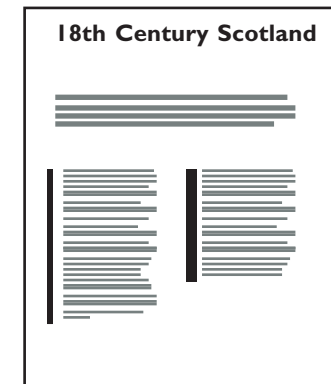

2.7 Exhibition graphics and labels: pictorial information

Photographs, illustrations and other images should have a matt surface. The image should be clear, have good contrast and be printed as large as possible and/or the important part of the image should be enlarged.

Avoid busy or confusing images, unless they are just part of the 'ambience' (not important to the story).

Allow a viewing distance of at least double the diagonal measurement of the image where possible, and the same for large objects etc. Remember to allow a distance of at least the minimum passageway width of 1200mm, or greater if the size of the image requires it.

2.8 Alternative formats of labels

Try always to provide label information in an alternative form, ie on tape, large-print hand-outs or braille. Remember, not all visitors can read text easily, even if it is well designed, and not everyone will be able to hear an audio facility clearly. The availability of these formats should be clearly signed at the entrance to the exhibition.

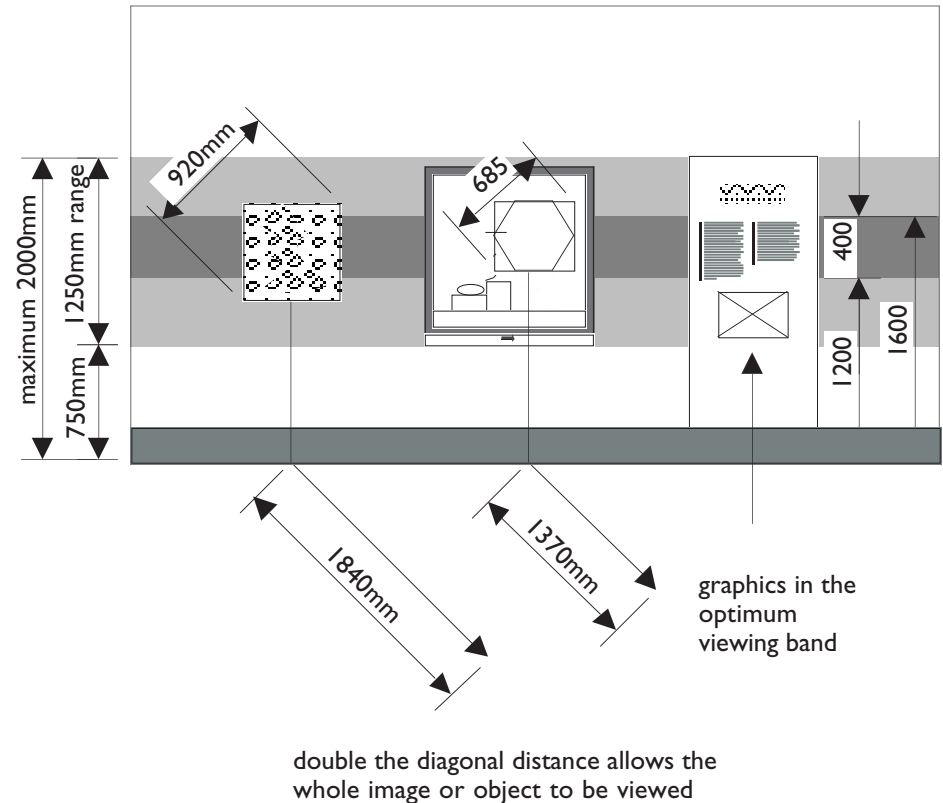

2.9 Typography and layout: general principles

Typeface

Both serif or sans-serif faces can be clear and legible and their use is largely one of personal preference. Select your typeface for legibility and suitability. The legibility of numerals should be considered. In some typeface's 3, 5 and 8 can sometimes be confused, as can 0 and 6.

Type style

Avoid italics and excessive use of capital letters as these letterforms affect the outline shape of words and are therefore more difficult to read.

what to avoid when choosing a font

what to avoid when choosing a font

WHAT TO AVOID WHEN CHOOSING A FONT

Avoid bizarre, decorative and unconventional letterforms as they detract from legibility.

WHAT TO AVOID WHEN CHOOSING A FONT
what to avoid when choosing a font
 WHAT TO AVOID WHEN CHOOSING A FONT

Type weight

Use a medium or bold weight and avoid light faces especially in smaller type sizes. Light letters can become indistinct and heavy letterforms begin to 'fill in' and become indistinct.

what to avoid when choosing a font

what to avoid when choosing a font

Type effects

Use your font in its true form. Avoid applying effects such as outline or shadow.

Outline Shadow

Type colour and background contrast

A significant feature of legibility of the text is the contrast between the text colour and the background that it is printed on. The higher the contrast between the two, the greater the legibility. Black on white or yellow is most legible. A minimum of 70% contrast is recommended for type to background, either dark on light or light on dark.

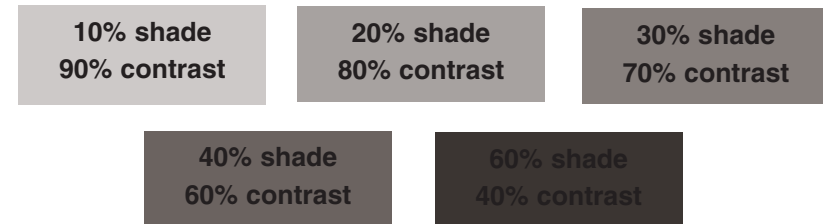

Ensure the combination of paper colour, ink colour and type style give high contrast and clear, legible text: ie use dark inks and pale backgrounds; never use yellow ink (unless combined with black); and avoid pale colours on a coloured background or those close in tone eg grey on blue. The graphic panel/label etc should also have good contrast against the background wall or case lining.

Over 10% of males and 0.5% of females have problems distinguishing red and green. Difficulties in distinguishing other colour combinations are less common. It is important not to ask visitors to make choices based on colour differentiation alone. People who are partially sighted often also have difficulty with colour perception, therefore colour contrast will not always be sufficient to distinguish text and background.

2.9 Typography and layout: general principles

Printing on textures

Printing type on a surface that is textured or has differing colours or tones can result in reduced legibility. Contrast between background and type is crucial.



Reversed text

Light text on a dark background presents an image which appears to be larger than non-reversed text, through the 'halo' effect. This can be used sparingly as an effective heading or to highlight a point. It should not be used for large areas of text as readers find it much more tiring to read than non-reversed.

Only use reversed-out text if the the face is clear, bold enough and large enough not to break up or fill in with ink. Ensure a good contrast between the lettering and the background.



Leading

Leading refers to the space allowed between each line of text. Legibility is increased when adequate leading is provided. Leading and word spacing are often best judged by eye rather than a set of rules. It may be helpful to try out samples with different spacings to choose the most appropriate.

example of very little leading which reduces legibility
example of very little leading which reduces legibility
example of very little leading which reduces legibility

Letter and word spacing,

Letters should never touch. Allow adequate, even spacing. Keep word spacing even. Do not condense or stretch lines of type to fit a particular measure.

condensed lettering

s t r e t c h e d l e t t e r i n g

Line lengths and columns

Line lengths of 50-75 characters, inclusive of spaces, are preferable. Allow adequate space between columns. Use rules to separate columns, if they must be close together, to help distinguish them. Try to avoid word-splits at the ends of lines and sentences running over to the next page.

2.9 Typography and layout: general principles

Justification hyphenation and layout

Range text left with a a ragged right hand margin This applies to main body text, while headlines or titles can be placed separately to add interest.

Avoid unnecessary hyphens. For example do not split a word at the end of a line by means of a hyphen unless it cannot be avoided. Preferably, put the whole word on the next line. Auto-hyphenation can happen as a word processing default in some software programmes and should always be switched off when laying out text.

Keep the layout consistent for a regular publication. Try to put similar articles in the same place or on the same page in each issue. If you find that you have too much text to fit into the space allowed, consider making the space larger rather than the type smaller.

Text orientation

The orientation of wording has great effect on its legibility, and it should be remembered that by changing the orientation of text from horizontal will reduce legibility for some of your audience. It is difficult for many users to read a word that is on its side running vertically. Sometimes this orientation is acceptable but should only be used very sparingly when required. Lettering placed on curves and unusual shapes can be effective when used as headings or titles but again this should be used sparingly and only for short phrases. Stacked lettering should never be used as it is very difficult to read the letter and word forms, greatly increasing reading and interpretation times.

Illustrations and text

Avoid running type over or around pictorial images. Overprinting (type on an imaged background) is difficult to read for people with low vision and should be avoided unless the image is used as a decorative or textural background and is not integral to the message within the text.

Where there is an alteration in the use of left hand justification, then the most appropriate form is to use a regular stagger

use text on curves sparingly



Do not run your text around images. Do not run your text around images. Do not run your text around images. Do not run your text around images. Do not run your text around images. Do not run your text around images. Do not run your text around images. Do not run your text around images. Do not run your text around images.

vertical orientation

Do not run your text over images Do not run your text over images Do not run your text over images Do not run your text over images Do not run your text over images Do not run your text over images Do not run your text over images Do not run your text over images Do not run your text over images Do not run your text over images

STACKED TEXT IS DIFFICULT TO READ

2.10 Printed / publicity material

Printed material is one of the primary means of outreach of an organisation. It is commonly the initial means of informing the user of the organisation's activities. Because the material is normally a purely visual medium, it is important to consider its impact on those with a visual disability.

Apply similar legibility criteria to posters, leaflets, invitations etc as to the texts in the exhibition. Any leaflets should be available in large clear print as standard. If this is not possible, provide an alternative leaflet in large print or other alternative format, depending on the nature of the exhibition and its target audience.

Publicity materials should include all relevant symbols, eg wheelchair symbol, 'T' symbol for inductive couplers or loops, and telephone, textphone and fax numbers where further information can be obtained.

2.11 Language

Know your readership.

Who will read the information you provide? The answer to this should guide what you say, how you say it and who should write it. Your readership may be clearly defined, such as schoolchildren of a certain age. In this case it can be quite clear how to write.

We commonly write for a much broader audience with a wide range of literacy skills. People who may find reading difficult include:

- people with learning difficulties, such as dyslexia.
- people who are 'functionally illiterate' (see 2.3)
- people whose first language is not English, such as Sign - language users and foreign visitors.

Using plain English is an effective way of making your message more widely understood.

2.12 Using plain English

Consulting

Writing in plain English starts with consulting your potential readers and finding out what they need to know and how they can best understand it.

- Allow plenty of time for the consultation process.
- Ask what information is relevant to your readers and what is not.
- Ask them if anything would aid their understanding of the text, such as symbols, drawings or photographs.
- Be prepared to consider alternatives to print, such as audio tape or video.
- Once you have written and laid out the information, consult your readers again before proceeding to print.
- Ask your readers to evaluate the finished product.

Writing

Plain English is clear and concise language, written with the reader in mind and with the right tone of voice. You can get information about writing in plain English from the Plain English Campaign website <http://www.plainenglish.co.uk>

In order to write information in plain English, you should:

- Plan what you want to say.
- Pare it down to the essential messages.
- Arrange it into sections that follow each other, one step at a time, in a logical order.
- Use everyday English.
- Avoid unnecessarily long or unfamiliar words.
- Avoid jargon or technical terms. If you have to use them, explain them or provide a glossary.
- Address the reader directly, perhaps asking questions and relating your information to everyday life.
- Keep your sentences short (on average 15 to 20 words) and simple.
- Avoid using commas and hyphens to tack extra clauses onto your sentences.
- Use active rather than passive verbs wherever you can.
- Repeat words rather than using synonyms.

- Make clear what action, if any, the reader has to take.
- Ask colleagues to read and edit your text. (You may even ask them to write it if you are not the best person to do so.)
- Always check that your information is accurate, clear, concise, readable and laid out in a helpful way.

Layout and Design

Many of the helpful ways in which printed information can be laid out are covered on pages 18 - 20. Extra ones to help people who find reading difficult are:

- Arrange the text in short chunks with headings and subheadings.
- Use bullets and boxes to break up the text and highlight important messages.
- Provide a clear list of contents and section headings.
- Quote addresses as they appear on the envelope, not laid out continuously on one or two lines.
- If your information is issued periodically, make sure that its layout is consistent from one issue to next.
- Consider enlarging the paper on which the information is issued so that larger print and more spacing is provided.
- Use images to support the text.

2.13 Print sizes for publicity material

Standard print sizes

Printed text intended for a general audience is usually between 8pt and 10pt in size and generally no larger than 12pt. This 'standard' size of text is not accessible to all, therefore standard print runs should always contain details of other formats when made available.

This is printed in Franklin Gothic 11pt.

Using point size as a guide

It should be noted that the point size is only a guide for some fonts due to their longer ascenders and descenders. Text produced in these fonts will therefore have to be made bigger than the recommended point sizes to be legible. It may be helpful to compare the legibility of these fonts to a standard Helvetica, as shown below.

This is text printed in 8 pt. Helvetica

This is text printed in 9 pt. Helvetica

This is text printed in 10 pt. Helvetica

This is text printed in 11 pt. Helvetica

This is text printed in 12 pt. Helvetica

This is text printed in 14 pt. Helvetica

This is text printed in 16 pt. Helvetica

Clear print

This term is used to describe print that is clearly laid out and easily read, which is legible to some partially sighted people. The points in section 2:12 layout, can be used as guidelines for designing clear print. RNIB guidelines note that clear print size should be a minimum of 12pt and recommend 14pt to reach more visitors with sight problems.

This is printed in Franklin Gothic 12pt.

This is printed in Franklin Gothic 14pt.

Large print

This term refers to print of a minimum size of 16pt and normally no larger than 22pt. This should also be clearly laid out and designed. If you are providing a large-print version of something, say so, in large print, in the standard-sized issue.

This is printed in Franklin Gothic 16pt.

Form design

If any of the material you are producing requires the user to fill in a questionnaire or address for mailing, make sure that adequate space has been allowed. Remember, not everyone has the same mobility and dexterity and they may require greater space to write.

2.14 Images

Images can be photographs, drawings or symbols.

- Choose the kind which your potential readers find most helpful.
- Link the text closely with the images.
- If using symbols, do not rely too heavily on them.
- Use drawings that are simple and attractive but not patronising.
- Well-chosen photographs can be more arresting and informative than any other kind of image.

2.15 Use of symbols

The use of recognised symbols representing facilities or levels of accessibility must provide accurate, reliable and meaningful information. It is important that the symbols advertise facilities which are actually available on visitors' arrival, and that staff know they are available. Clear descriptions produce more realistic customer expectations. Many symbols are internationally recognised, overcoming language barriers. Where there are no symbols available, describe the facility in clear straightforward text.



Denotes building, exhibition or lecture is wheelchair-accessible



Stepped access with number of steps indicated



Ramped entrance



Wheelchair-accessible lift



Symbol for induction loop



Symbol for infrared system or device for enhanced sound



Symbol for text or information designed to be accessible for people with visual impairments.



Sign interpretation/language available



Guide or hearing dogs welcome.



Baby-changing facilities

2.16 Paper and printing

Use matt or silk-finish papers and inks. Glossy surfaces can create glare or reflection. Avoid thin or semi-transparent papers which allow show-through.

2.17 Alternative formats

If your readers find printed information difficult to see or understand, consider providing it on audiotape, videotape, CD, Braille, or PC diskette. If someone communicates with you using an alternative format, try to reply in the same format.

- Keep your main messages short and simple.
- On audiotapes tell the listener when to turn over and when the recording ends. If the recording is long, provide a sound signal at the beginning of each section, to help the user find the section they want to listen to.
- Be consistent with your use of numbers, pronouncing 0 as 'zero' not 'oh'.
- If replying by e-mail remember that formatting can be lost.

3.1 Audio visuals and subtitles

Audio-visual presentations (including tape-slide, video, film, and computer / multimedia interactives) are commonly used in museums to give information and enhance exhibitions. As such they constitute a service to the public. However this service can be inaccessible to deaf and hard-of-hearing visitors if the information conveyed by sound is not provided in an alternative way.

The Royal National Institute for Deaf People estimates that around 8.7 million adults in the UK are deaf or have a significant hearing loss. Providing subtitles is an effective alternative way of making audio-visual programmes accessible to this part of the community and of meeting our legal requirements under the Disability Discrimination Act.

Exhibition organisers and designers must therefore take into account the provision of subtitles as an integral element of any audio-visual presentation. Costs and timescales for production of this facility should be considered in the initial feasibility study.

3.2 Production and appearance of subtitles

When purchasing subtitles the following recommendations on production and appearance should be followed.

- Scripts provided for subtitle production should be as close to the audio script as possible and must never modify the central message.
- Always request a script for checking and proofreading prior to the production and application of the subtitles. A further 'on screen' proofread should be undertaken to ensure the titles are correctly applied.

- Subtitles, positioned centrally at the bottom of the moving image, are always preferred to other text positions unless viewing conditions demand otherwise.
- Stationary, not scrolling, subtitles with captioned music and speech are preferred.
- White lettering on a black solid background or shadowbox is most effective. Different coloured backgrounds can be used to indicate different speakers. Green backgrounds should be used sparingly.
- Allow three seconds to read one line, six for two. More than two lines is intrusive on the image.
- The inclusion of visible logo stamps on footage bought from libraries or institutional sources should be avoided and negotiated for exclusion within the usage copyright contract. Credits can always be provided after the presentation which removes this additional distraction.
- The costs and timescale for the production of subtitles should be allowed for in the overall budget and production timetable. Normally 3-4 weeks should be allowed for this.
- Master tapes should be provided in Betacam or High Band Umatic (PAL) formats.
- See page 32, for useful contact addresses for producing subtitles.

3.3 Presentations without subtitles

If acquiring an audio-visual presentation, or an exhibition containing one, the exhibition organiser or designer must ensure that it is subtitled. In the unlikely event that subtitling it is impossible, consider withdrawing the AV altogether from the exhibition or providing a transcript.

A transcript is a reasonable alternative method of providing the service only if the visual information is relatively static, eg a "talking head". Lighting levels should, in this situation, be adequate for reading text within the presentation area.

3.4 Silent presentations / presentations with music

If the presentation is silent, a sign with this information should be provided, viewable within the AV area, to inform deaf visitors that they are not missing audio information. Presentations without narration but containing music which is significant to the presentation should provide the title of the music and any lyrics, as subtitles.

3.5 Other AV considerations

All AV presentations (including those with subtitles) should have a device for enhanced sound fitted and denoted by the appropriate symbol. Such devices are of two types, both of them are used with the user's hearing aid switched to the T position. One provides an amplified signal by means of an induction loop surrounding the AV area: the other by means of an infrared headset. An infrared system has the advantage of being able to be used to transmit simultaneous interpretation, eg foreign language or audio description.

Sound recording and reproduction should be of very good quality. Background noise, in particular, can be both distracting and irritating, causing frustration and loss of interest to the viewer.

Where audio visuals are installed, seating should be allowed, for visitors to pause and enjoy them as well as wheelchair spaces not less than 900mm wide x 1400mm deep, with standard seating adjacent for a companion. Avoid confusion of sound from competing AV installations

or excessive sound spillage into other areas of the exhibition.

Indicate the running time of the presentation and how often it is shown, ideally both on-screen and as a graphic displayed near the AV presentation area.

Fluorescent light fittings, heavy electrical cabling and digital or mobile telephones can interfere with the signal picked up by a hearing aid. AV presentations should be placed where such interference is minimal.



Symbol for induction loop or device for enhanced sound to be used in conjunction with a hearing aid switched to the 'T' position.



Symbol for infrared enhanced sound system

4.1 Lighting entrances and main routes

Generally, avoid extreme contrasts in lighting: aim for uniformity or gradual changes, including a lighting transition zone between the external environment and the generally low lighting levels in most galleries.

Where shadows, pools of dark and light, etc are desirable for ambience, utilise them with care, and only in contained areas such as a dark, evocative set. Such areas should not be on the main circulation route, and the surrounding area must be well lit. Avoid unexpected shadows, glare, reflection or a criss-crossing of light sources, which create visual confusion.

Ensure all entrances, exits, stairs, ramps or obstacles are well lit, and use light to accentuate differences in planes, colour and texture to act as visual clues for orientation.

4.2 Display lighting

Good lighting is particularly important for visually impaired and older people who tend to need more illumination to read labels and graphics. Ensure that adequate lighting is provided on the vertical planes of your graphic displays.

Use non-reflecting glass or film on all interactives, cases, displays, paintings etc wherever reasonable, for ease of lighting. Ensure lights do not dazzle the viewer or that the viewer does not cast shadows on the objects. Check this from the height of a wheelchair user as well as at standing height.

Ensure task lighting (or daylight) on interactive computer screens does not cause glare, and allow individual adjustment by the visitor where possible.

When low light levels are called for, find the best compromise between conservation requirements and those of disabled people. Consider temporary illumination of objects eg by timed push-button.

Cases or areas which are low-lit for conservation reasons should be provided with a notice explaining that this is to protect light-sensitive artifacts.

Levels of reflectance from wall finishes and materials used for graphic and object displays will greatly affect the perceived light levels within an exhibition. The lighter the colour the greater the reflected light (the light seen by the eye).

In spaces that are lit by both natural and artificial light sources it must be remembered that lighting conditions will be constantly changing. In displays with these lighting conditions it is important to have a lighting scheme that works without natural light for evening events or seasonal changes. Lighting schemes can be designed with automatic light sensors which will increase or decrease the light from the artificial sources depending on the overall light levels.

4.3 Lighting maintenance

Good maintenance is crucial to keep your lighting scheme effective and in good order. Replacing lamps throughout a gallery on an annual basis will avoid frequent breakdowns as lamps reach the end of their life. When using this system of replacement, attention should also be given to maintaining the focus of each light fitting to the designer's specification.

4.4 Light levels

Light levels can vary depending on the type of exhibition, the material being displayed and desired ambience. Conservation requirements for light-sensitive materials will require low light levels and/or limited exposure. However clarity of the overall display and interpretive information should always be given careful consideration.

Artefacts can be divided into three categories of light sensitivity.

Insensitive to light:

metals, stone, ceramics, glass and enamels

Sensitive to light:

oil paintings, wood, ivory, bone, some works of art on paper

Very sensitive to light:

textiles, most works of art on paper, fur and feathers, dyed leather

area	light levels
displays (light sensitive)	50 lux (very sensitive) to 150 lux (sensitive) (depending on material)
displays (insensitive to light)	no maximum light level
signage and text panels	50 lux above surrounding levels
work surface (general)	300-400 lux (plus task lighting)
work surface (detailed work)	400-1000 lux (from task lighting)

The light levels listed refer to planar illuminance, measured with a light meter in units of lux. Recommended light levels for organic or light-sensitive exhibits are often also specified in kilolux (klux) hours as cumulative exposure levels. Using klux hours as a method of

measuring exposure to light can allow some light-sensitive exhibits to be more brightly lit if they are on display for a shorter time. (However it has to be recognised that this simply limits the damage to the equivalent of that caused by lower illumination for a longer time: the ideal is to minimise total light exposure for very sensitive artefacts).

Usually there is no limit on light levels for display panels and exhibition graphics. Exceptions to this may include panels that incorporate artefacts, or panels placed close to light-sensitive displays that may reflect additional light onto the artefacts. Care should be taken not to use dramatic changes of light levels within a gallery as this will cause eye strain and fatigue for the visitor.

4.5 Light colour/quality

The colour of light, produced from different lamp sources, is also important if correct colour interpretation of artefacts is to be perceived by viewers. Daylight equivalent lamps may be appropriate and the colour tint of solar or UV control film need to be carefully chosen.

When sensitive or very sensitive material is being displayed it is also very important to exclude ultra-violet (UV) light which which is significantly more damaging than visible light. This can be easily achieved by UV filters or selecting light sources which do not emit UV light.

With the above factors in mind, it is therefore important to consult with a conservator and lighting designer early in an exhibition's development and design.

5.1 Statutory obligations

It is the design consultants' responsibility to ensure that their designs comply with all statutory regulations that affect the structure and layout within the exhibition, and to obtain the necessary warrants and certificates. The following is an indication of requirements that affect exhibitions:

- The Building Standards (Scotland) Regulations 1990 (5th edition with amendments issued up until 1999).
- For England and Wales refer to the Building Regulations 1991 and for Northern Ireland refer to Building Regulations Northern Ireland) 1990 & Amendments.
- The Fire Precautions Act 1971
- British Standards (strictly not legislation, but the standards adopted by many statutory acts). In particular, consult BS 5810: 1979 Code of Practice for Access for the Disabled to Buildings.
- Public Entertainment Licence (normally granted by the local authority)
- The Disability Discrimination Act 1995.
(For free factsheets and booklets, see website www.disability.gov.uk or contact DDA Helpline tel 0345 622633).
fax 0345 622611, textphone 0345 622644,
e-mail ddahelp@stra.sitel.co.uk
- Health & Safety at Work Act 1974

5.2 Voluntary guidelines

The following voluntary organisations and/or their publications have been consulted in drawing together these guidelines, and further information may be obtained from these organisations where necessary:

- **Centre for Accessible Environments**

Nutmeg House,
60 Gainsford Street,
London SE1 2NY

Tel/minicom: 020 7357 8182

Fax: 020 7357 8183

e-mail: cae@globalnet.co.uk

Website: www.cae.org.uk

- **Resource, The Council for Museums, Archives and Libraries**

16 Queen Anne's Gate,
London SW1H 9AA

Tel: 020 7233 4200

Fax: 020 7233 3686

Website: www.resource.gov.uk

- **The Scottish Arts Council**

12 Manor Place,
Edinburgh EH3 7DD

Telephone: 0131 226 6051

Fax: 0131 225 9833

- **RNIB & GDBA Joint Mobility Unit, RNIB Scotland**

10 Magdala Crescent,
Edinburgh EH12 5BE

Telephone: 0131 346 1966

Fax: 0131 313 1875

- **The Arts Council of England**

14 Great Peter Street,
London SW1P 3NQ

Tel: 020 7333 0100

Fax: 020 7973 6590

- **The Royal National Institute for the Blind**

224 Great Portland St,
London W1N 6AA

Telephone: 0171 388 1266

Fax: 0171 388 2706

- **Royal National Institute for Deaf People**

19-23 Featherstone Street
London EC1Y 8SL

Telephone: 020 296 8000

Fax: 020 7296 8199

Minicom: 020 7296 8001

Website: www.rnid.org.uk

- **Mencap**

Mencap National Centre
123 Golden lane
London EC1Y 0RT

Telephone: 020 7474 0454

Website: www.mencap.org.uk

5.3 Useful addresses

- **The National Subtitling Library for Deaf People**

3rd floor, Victoria Mill
Andrew Street, Compstall, Stockport,
Cheshire SK6 5HN

Tel: 0161 449 9650

- **Chase Video productions**

Royal School for the Deaf
Ashbourne Road,
Derby, DE22 3BH

Tel: 01332 362512

5.4 Useful reading

The number of publications on disability issues is vast. Publications that may be of use to designers are:

Books and packs

- Barker, Peter et al. *Building Sight*. London: HMSO/RNIB, 1995
- Barker, Peter and Fraser, June. *The sign design guide: a guide to inclusive signage*. London: Harpenden, Hertfordshire JMU, 2000
- *BT Countryside for all: standards and guidelines*. Sheffield: BT Countryside for all, 1997
- Centre for Accessible Environments. *Access Audits*. London: Centre for Accessible Environments, 1999
- Diffrient, Niels et al. *Humanscale*. Massachusetts: The MIT Press, 1990
- Gill, John. *Access Prohibited? Information for Designers of Public Access Terminals*. London: RNIB, 1997
- Goldsmith, Selwyn. *Designing for the Disabled*. London: RIBA Publications, third edition, 1984
- Gregory, Wendy. *The Informability Manual*. London: HMSO, 1996
- Rayner, Ann. *Access in Mind: Towards the Inclusive Museum*. Edinburgh: INTACT, 1998

- Royal National Institute for the Blind. *See it right*. pack, (12 booklets). RNIB, 2001

- *Smithsonian Guidelines for Accessible Exhibition Design*. Washington, DC: Smithsonian Institution, 1996

Journals

- *Access by Design*, quarterly magazine of the Centre for Accessible Environments
- *Barrierfree*, quarterly magazine of the Museums and Galleries Disability Association

CD-ROM

- The ADAPT Trust. *Open Sesame: the magic of access*. Edinburgh: The ADAPT Trust, 1999

Video

- *Access by Design, Implementing the Disability Discrimination Act 1995*. London: Centre for Accessible Environments, 1996

Disability facts and figures

The following figures give some indication of the nature and extent of people with disabilities in the UK. They demonstrate that a large percentage of the population are affected by both physical obstacles and other imposed barriers. By addressing the needs of people with disabilities, a significant new audience (and their family and friends) can enjoy the attractions of museums and galleries. All figures apply to the UK unless otherwise stated.

General figures

- Total population: 58.4 million
- 6.4 million people (approximately 11% of the population) are disabled
- 2.4 million people with disabilities are of working age
- 69% of people with disabilities of working age are unemployed

People with mobility difficulties

- It is estimated that 10 million people have impaired mobility (RNIB)
- In Scotland there are 14,500 new wheelchair users per year (Scottish Executive)
- Under 5% of people with disabilities use a wheelchair
- In Scotland 30% of people with health problems or disabilities expected to last more than a year said the problem concerned their arms, hands, legs or feet (Scottish Executive)

People with visual impairment

(figures relate to people over 16 years old)

- 1.1 million people have severe visual impairment (eligible to be registered blind or partially sighted)
- 1.7 million people are visually impaired to the extent that they are unable to read standard print easily, and many more people experience problems with poor eyesight
- 4% of blind people have no light perception at all
- 36% of blind people can read large print
- 75% of partially sighted people can read large print
- 19,000 (approximately 2%) of people registered as visually impaired can read braille
- 24% of blind people use information on audio tape
- 6% of partially sighted people use information on audio tape
- 97% of people over 65 wear glasses
- 90% of people with visual impairment are over 60
- 10% of Males but fewer than 0.5% of females have problems distinguishing red / green. (*Access Prohibited?* John Gill)

People with hearing impairment

- 8.4 million people (approximately 14%) have a hearing impairment
- 18% of people in Scotland are estimated to have a hearing loss (Scottish Executive)
- Approximately 2 million use a hearing aid
- 250,000 have profound hearing loss
- 60% of people with hearing impairment are over 70
- 33% of people over 65 have hearing difficulties
- 45% of deaf people under 60 have other disabilities
- 77% of severely or profoundly deaf people over 60 have other disabilities
- 62,000 deaf people use British Sign Language
- 97% of deaf people have access to colour television with teletext
- 420,000 are unable to use a voice telephone

People who are deaf-blind

- 250,000 people have both visual and hearing impairment

People with learning difficulties

- 1.2 million people (2% of the UK population) have learning difficulties (Mencap)
- About 70% have an additional disability (Mencap)
- Mental illness can cause temporary learning difficulties - 6 million people per year in England are diagnosed as having a mental health problem

Definitions.

Profound learning disability is approximated as being equivalent to IQ under 20; moderate and severe learning disability to IQ less than 50; mild learning disability to IQ under 70. Learning disability is now usually measured by a range of intellectual abilities and social skills. (Mencap)

It is particularly important not to attach too much importance to “mental age”: an adult with an IQ of less than 20 is still an adult, not an infant, and will have many adult characteristics and behaviours...and the right to be treated as an adult. (Mencap)

Older people

- 9 million people (approximately 15%) are aged over 65
- 6 million people (over 10%) are aged over 70
- 50% of people with disabilities are aged over 70
- 25% of Europeans will be aged over 60 by the year 2020
- People over 65 account for 15% of adults with severe learning disabilities (Mencap)

Children and young people

- 3% of pupils in Scottish primary schools and 4% of pupils in Scottish secondary schools have special educational needs, SENs. (Scottish Executive, 1999)
- 25% of all children in Scotland with SENs study in special schools. (Scottish Executive, 1999)
- 5% of students studying for a first degree in Scottish higher education institutions have a self-defined disability. (Scottish Executive, 1998-99)

Literacy

- 7.3 million adults have literacy problems
- In the UK approximately 1 in 5 adults is estimated to have functional illiteracy, meaning he or she finds it difficult to read and write at the level required to cope best with all aspects of daily life. (Moser, 1999)
- The City of Edinburgh Council uses the following definition of literacy: “the ability to read, write and use numeracy, to handle information, to express ideas and opinions, to make decisions and solve problems, as family members, workers, citizens and lifelong learners”.

All figures courtesy of *The Informability Manual* by Wendy Gregory, unless otherwise stated. Crown copyright is reproduced with the permission of the Controller of Her Majesty’s Stationery Office.